



**FAHRZEUG-
EINRICHTUNGEN**



**STORE
BOXSERIES**



STORE BOX067
S. 4



STORE BOX080
S. 6



STORE BOX102
S. 10



STORE BOX136
S. 12



STORE BOX238
S. 14



STORE BOX374
S. 16



STORE BOXTRAY
S. 18



STORE ROLL
S. 22



**STORE
BOXDIVIDER**
S. 20



**STORE
CADDY**
S. 23



STORE BOX067

ART. NR. F 22 SB BOX067 00 01

Stahlkoffer, leer B=438 T=347 H=67 mm



ART. NR. F 22 SB BOX067 01 01

Stahlkoffer mit 48 Fächern:
48 Insert Boxen "red"



ART. NR. F 22 SB BOX067 02 01

Stahlkoffer mit 24 Fächern:
24 Insert Boxen "yellow"



ART. NR. F 22 SB BOX067 03 01

Stahlkoffer mit 12 Fächern:
12 Insert Boxen "blue"



ART. NR. F 22 SB BOX067 04 01

Stahlkoffer mit 8 Fächern:
8 Insert Boxen "green"



ART. NR. F 22 SB BOX067 05 01

Stahlkoffer mit 4 Fächern:
4 Insert Boxen "forest"



ART. NR. F 22 SB BOX067 06 01

Stahlkoffer mit 23 Fächern:
12 Insert Boxen "red"
6 Insert Boxen "yellow"
3 Insert Boxen "blue"
2 Insert Boxen "green"

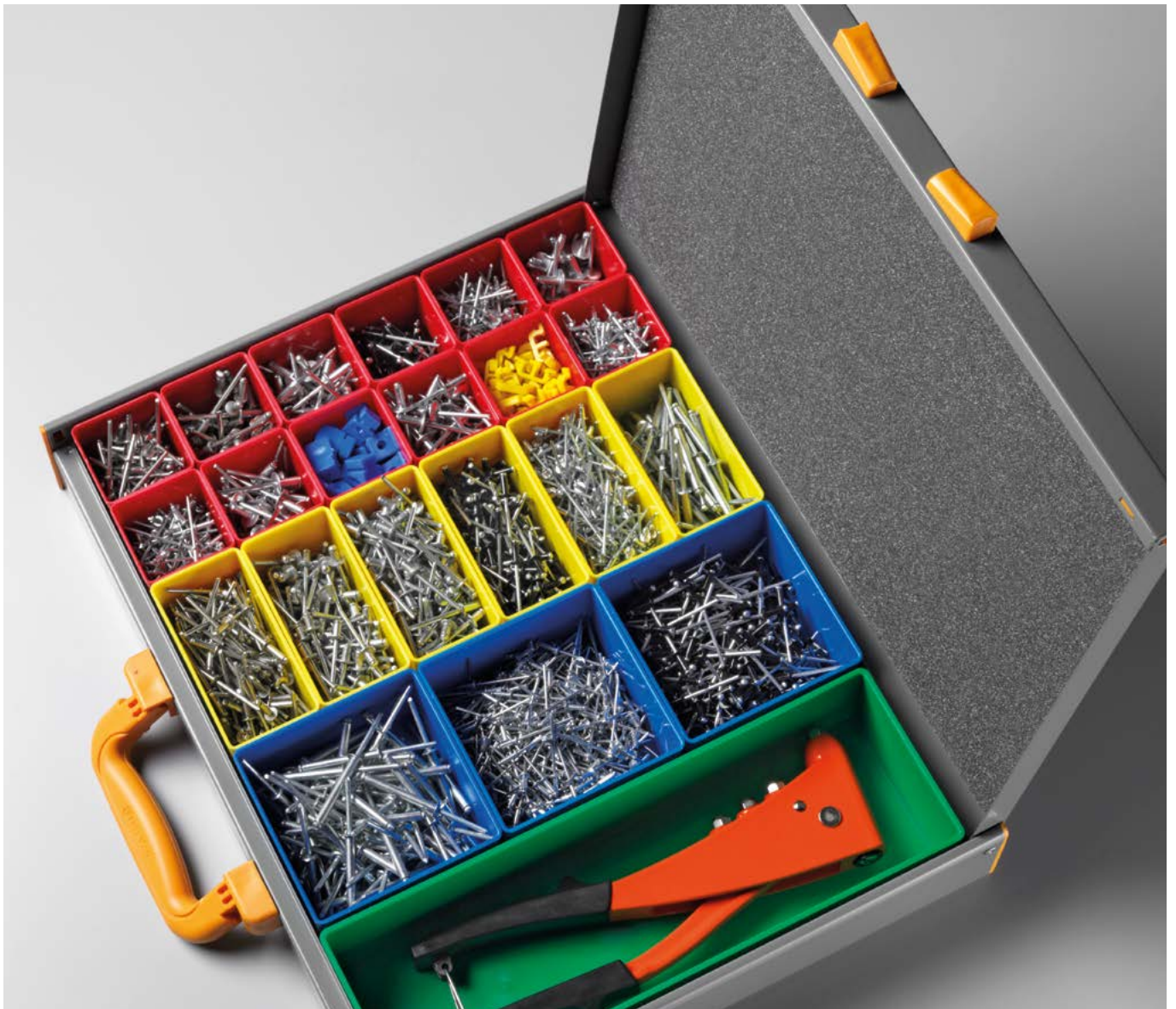

ART. NR. F 22 SB BOX067 07 01

Stahlkoffer mit 16 Fächern:
 6 Insert Boxen "red"
 5 Insert Boxen "yellow"
 2 Insert Boxen "blue"
 2 Insert Boxen "green"
 1 Insert Box "forest"



ART. NR. F 22 SB BOX067 08 01

Stahlkoffer mit 10 Fächern:
 3 Insert Boxen "yellow"
 3 Insert Boxen "blue"
 3 Insert Boxen "green"
 1 Insert Box "forest"



ART. NR. F 22 SB BOX067 09 01

Stahlkoffer mit 22 Fächern:
 12 Insert Boxen "red"
 6 Insert Boxen "yellow"
 3 Insert Boxen "blue"
 1 Insert Box "forest"



STORE BOX080

ART. NR. F 22 SB BOX080 00 01

Kunststoffkoffer, leer B=440 T=350 H=80 mm



ART. NR. F 22 SB BOX080 01 01

Kunststoffkoffer mit 48 Fächern:
48 Insert Boxen "red"



ART. NR. F 22 SB BOX080 02 01

Kunststoffkoffer mit 24 Fächern:
24 Insert Boxen "yellow"



ART. NR. F 22 SB BOX080 03 01

Kunststoffkoffer mit 12 Fächern:
12 Insert Boxen "blue"



ART. NR. F 22 SB BOX080 04 01

Kunststoffkoffer mit 8 Fächern:
8 Insert Boxen "green"



ART. NR. F 22 SB BOX080 05 01

Kunststoffkoffer mit 4 Fächern:
4 Insert Boxen "forest"



ART. NR. F 22 SB BOX080 06 01

Kunststoffkoffer mit 23 Fächern:
12 Insert Boxen "red"
6 Insert Boxen "yellow"
3 Insert Boxen "blue"
2 Insert Boxen "green"

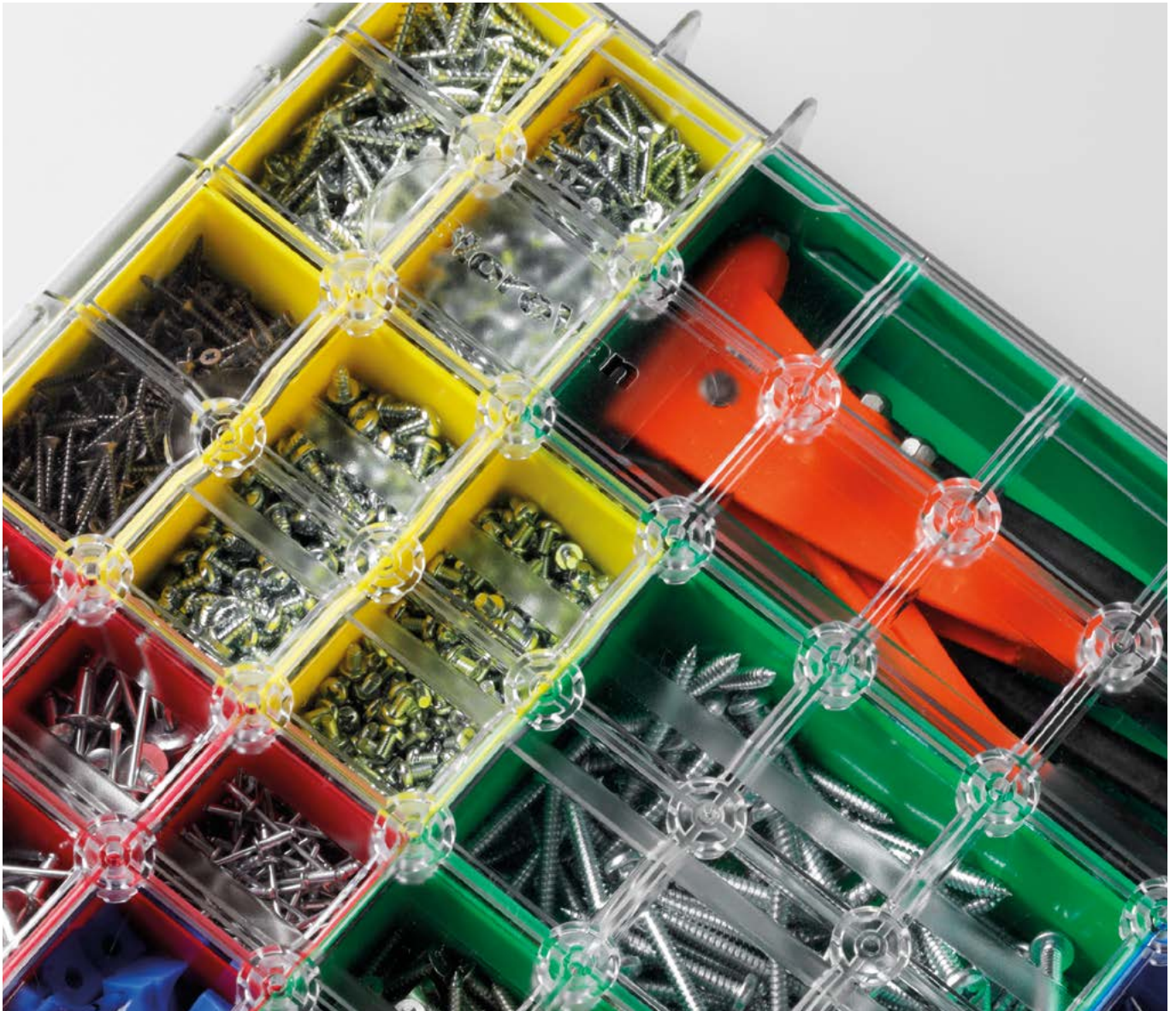

ART. NR. F 22 SB BOX080 07 01

Kunststoffkoffer mit 16 Fächern:
 6 Insert Boxen "red"
 5 Insert Boxen "yellow"
 2 Insert Boxen "blue"
 2 Insert Boxen "green"
 1 Insert Box "forest"



ART. NR. F 22 SB BOX080 08 01

Kunststoffkoffer mit 10 Fächern:
 3 Insert Boxen "yellow"
 3 Insert Boxen "blue"
 3 Insert Boxen "green"
 1 Insert Box "forest"



ART. NR. F 22 SB BOX080 09 01

Kunststoffkoffer mit 22 Fächern:
 12 Insert Boxen "red"
 6 Insert Boxen "yellow"
 3 Insert Boxen "blue"
 1 Insert Box "forest"



STORE BOX102

ART. NR. F 22 SB BOX102 00 01

Kunststoffkoffer, leer B=442 T=357 H=117 mm



ART. NR. F 22 SB BOX102 01 01

Kunststoffkoffer mit 23 Fächern:
1 Deckel sky
2 Insert Boxen "grey" mit Einteilern
6 Insert Boxen "red"
6 Insert Boxen "yellow"
3 Insert Boxen "blue"



ART. NR. F 22 SB BOX102 02 01

Kunststoffkoffer mit 19 Fächern:
1 Deckel sky
2 Insert Boxen "grey" mit Einteilern
4 Insert Boxen "red"
3 Insert Boxen "yellow"
2 Insert Boxen "blue"
2 Insert Boxen "green"



ART. NR. F 22 SB BOX102 03 01

Kunststoffkoffer mit 18 Fächern:
1 Deckel sky
2 Insert Boxen "grey" mit Einteilern
4 Insert Boxen "red"
3 Insert Boxen "yellow"
2 Insert Boxen "blue"
1 Insert Box "forest"



ART. NR. F 22 SB BOX102 04 01

Kunststoffkoffer mit 38 Fächern:
1 Deckel sky
2 Insert Boxen "grey" mit Einteilern
30 Insert Boxen "red"



ART. NR. F 22 SB BOX102 05 01

Kunststoffkoffer mit 23 Fächern:
1 Deckel sky
2 Insert Boxen "grey" mit Einteilern
15 Insert Boxen "yellow"



ART. NR. F 22 SB BOX102 06 01

Kunststoffkoffer mit 13 Fächern:
1 Deckel sky
2 Insert Boxen "grey" mit Einteilern
5 Insert Boxen "green"

ART. NR. F 22 SB BOX102 07 01

Kunststoffkoffer mit 14 Fächern:
 1 Deckel sky
 2 Insert Boxen "grey" mit Einteilern
 2 Insert Boxen "red"
 2 Insert Boxen "yellow"
 2 Insert Boxen "forest"

ART. NR. F 22 SB BOX102 08 01

Kunststoffkoffer mit 17 Fächern:
 1 Deckel sky
 2 Insert Boxen "grey" mit Einteilern
 3 Insert Boxen "yellow"
 6 Insert Boxen "blue"

ART. NR. F 22 SB BOX102 09 01

Kunststoffkoffer mit 14 Fächern:
 1 Deckel sky
 2 Insert Boxen "grey" mit Einteilern
 3 Insert Boxen "blue"
 3 Insert Boxen "green"

ART. NR. F 22 SB BOX102 10 01

Kunststoffkoffer mit:
 1 Deckel sky
 2 Insert Boxen "grey" mit Einteilern
 2 store box mini63

ART. NR. F 22 SB BOX102 11 01

Kunststoffkoffer mit:
 1 Deckel sky
 1 Kleinteile-Organizer "dark" mit 5 Fächern

ART. NR. F 22 SB BOX102 12 01

Kunststoffkoffer mit:
 1 Deckel sky
 1 Kleinteile-Organizer "dark" mit 12 Fächern



STORE BOX102

ART. NR. F 22 SB BOX102 00 01

Kunststoffkoffer, leer B=442 T=357 H=117 mm

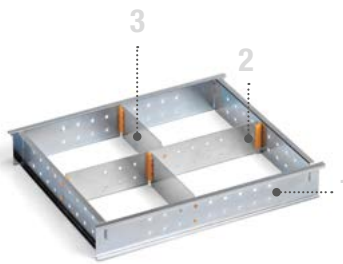

ART. NR. F 22 SB FRA102 01 99

B=406 T=319 H=61 mm
Einteilungsset mit:
1 Rahmen FRA102
1 Einteiler D35102
2 Einteiler D13102

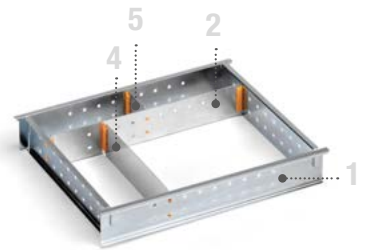

ART. NR. F 22 SB FRA102 02 99

B=406 T=319 H=61 mm
Einteilungsset mit:
1 Rahmen FRA102
1 Einteiler D35102
1 Einteiler D06102
1 Einteiler D21102



ART. NR. F 22 SB FRA102 00 99

Verzinkter Stahlrahmen für Koffer
BOX102
B=406 T=319 H=61 mm



2

ART. NR. F 22 SB D35102 00 00

Quereinteiler aus Aluminium für
Rahmen für BOX102
B=352 T=12 H=61 mm



3

ART. NR. F 22 SB D13102 00 00

Längseinteiler aus Aluminium
für Rahmen für BOX102
B=139 H=60 mm



4

ART. NR. F 22 SB D21102 00 00

Längseinteiler aus Aluminium
für Rahmen für BOX102
B=218 H=60 mm



5

ART. NR. F 22 SB D06102 00 00

Längseinteiler aus Aluminium
für Rahmen für BOX102
B=61 H=60 mm

ART. NR. F 22 SB MAT001 00 07

Rutschfester Gummiteppich für
BOX102 - 136 - 238
B=362 T=300 H=1,5 mm

ART. NR. F 22 SB SKY001 00 07

Deckel Sky aus Polypropylen-Schaumstoff
B=400 T=320 H=20 mm

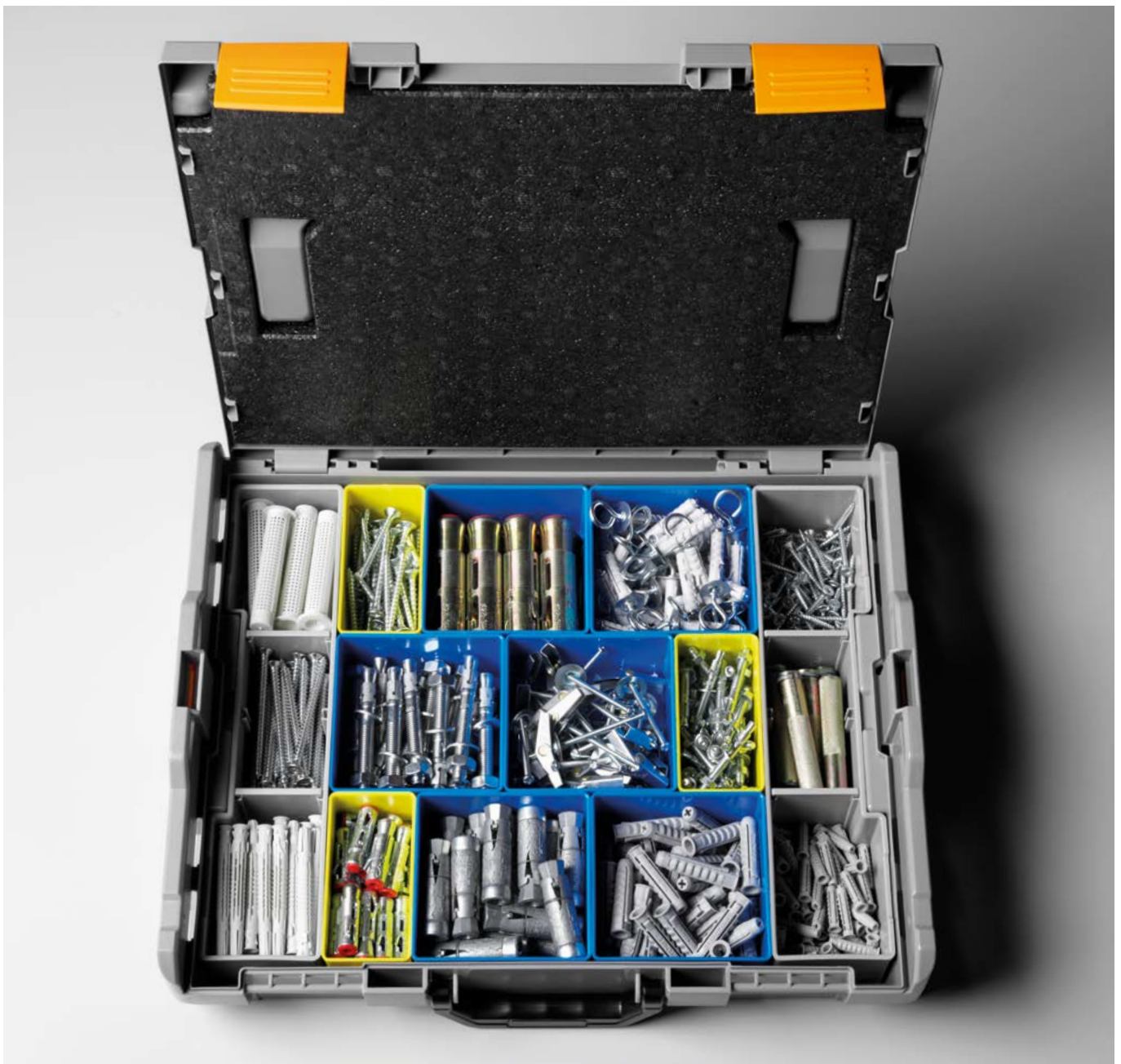



STORE BOX136

ART. NR. F 22 SB BOX136 00 01

Kunststoffkoffer, leer B=442 T=357 H=151 mm

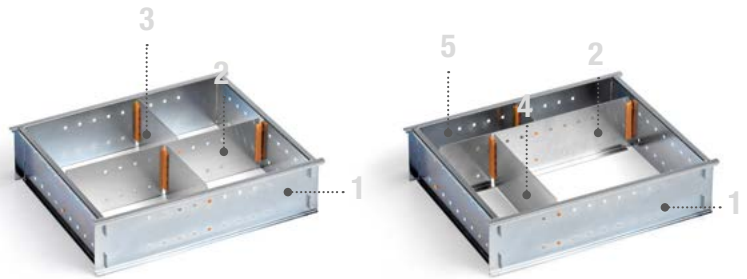

ART. NR. F 22 SB FRA136 01 99

B=406 T=319 H=96 mm
Einteilungsset mit:
1 Rahmen FRA136
1 Einteiler D35136
2 Einteiler D13136

ART. NR. F 22 SB FRA136 02 99

B=406 T=319 H=96 mm
Einteilungsset mit:
1 Rahmen FRA136
1 Einteiler D35136
1 Einteiler D06136
1 Einteiler D21136



ART. NR. F 22 SB FRA136 00 99

Verzinkter Stahlrahmen für Koffer
BOX136
B=406 T=319 H=96 mm



2

ART. NR. F 22 SB D35136 00 00

Quereinteiler aus Aluminium für
Rahmen für BOX136
B=352 T=12 H=96 mm



3

ART. NR. F 22 SB D13136 00 00

Längseinteiler aus Aluminium
für Rahmen für BOX136
B=139 H=95 mm



4

ART. NR. F 22 SB D21136 00 00

Längseinteiler aus Aluminium
für Rahmen für BOX136
B=218 H=95 mm



5

ART. NR. F 22 SB D06136 00 00

Längseinteiler aus Aluminium
für Rahmen für BOX136
B=61 H=95 mm



ART. NR. F 22 SB MAT001 00 07

Rutschfester Gummiteppich für
BOX102 - 136 - 238
B=362 T=300 H=1,5 mm

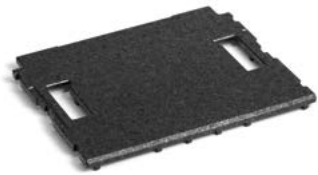

ART. NR. F 22 SB SKY001 00 07

Deckel Sky aus Polypropylen-Schaumstoff
B=400 T=320 H=20 mm



Deckel sky

Tablar mit
Einteilungsset
siehe S. 18



1

ART. NR. F 22 SB SUP136 00 99

Tragrahmen aus verzinktem Stahl für Koffer BOX136
B=401 T=311 H=32 mm





STORE BOX238

ART. NR. F 22 SB BOX238 00 01

Kunststoffkoffer, leer B=442 T=357 H=253 mm

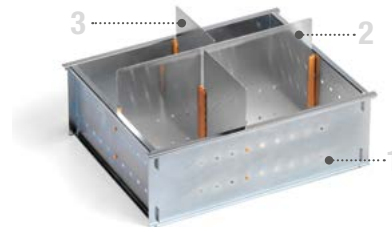

ART. NR. F 22 SB FRA238 03 99

B=402 T=312 H=194 mm

Einteilungsset mit:

1 Rahmen FRA238

1 Einteiler D36238

2 Einteiler D14238



1

ART. NR. F 22 SB FRA238 00 99

Verzinkter Stahlrahmen für Koffer
BOX238 - BOX374
B=402 T=312 H=132 mm



2

ART. NR. F 22 SB D36238 00 00

Quereinteiler aus Aluminium für
Rahmen für BOX238
B=352 T=12 H=194 mm



3

ART. NR. F 22 SB D14238 00 00

Längseinteiler aus Aluminium
für Rahmen für BOX238
B=135 H=193 mm

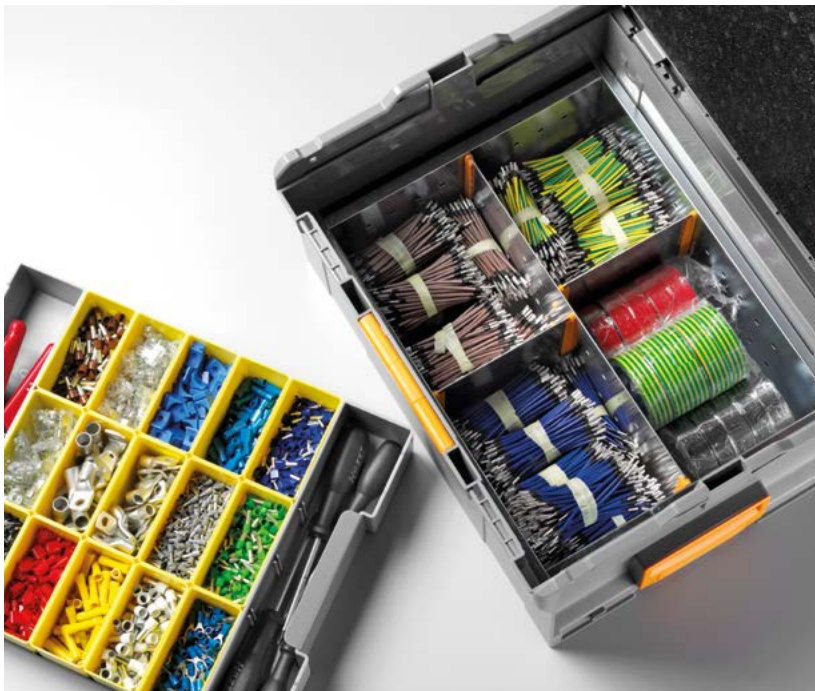

ART. NR. F 22 SB MAT001 00 07

Rutschfester Gummiteppich für
BOX102 - 136 - 238
B=362 T=300 H=1,5 mm

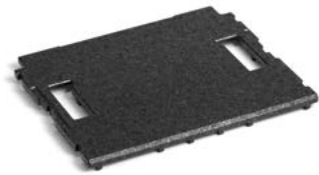

ART. NR. F 22 SB SKY001 00 07

Deckel Sky aus Polypropylen-Schaumstoff
B=400 T=320 H=20 mm



Deckel sky

Tablar mit
Einteilungsset
siehe S. 18

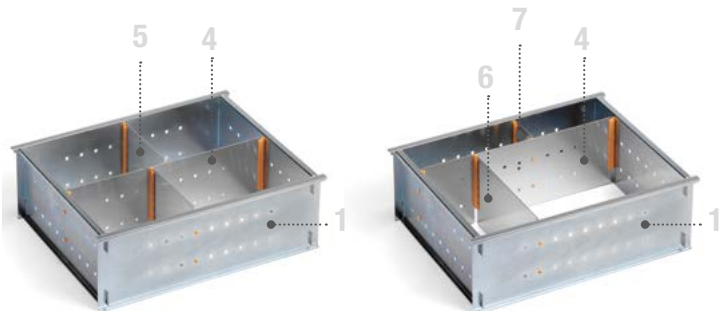

ART. NR. F 22 SB FRA238 01 99

B=402 T=312 H=132 mm
Einteilungsset mit:
1 Rahmen FRA238
1 Einteiler D35238
2 Einteiler D13238

ART. NR. F 22 SB FRA238 02 99

B=402 T=312 H=132 mm
Einteilungsset mit:
1 Rahmen FRA238
1 Einteiler D35238
1 Einteiler D05238
1 Einteiler D21238



1

ART. NR. F 22 SB FRA238 00 99

Verzinkter Stahlrahmen für Koffer
BOX238 - BOX374
B=402 T=312 H=132 mm



4

ART. NR. F 22 SB D35238 00 00

Quereinteiler aus Aluminium für
Rahmen für BOX238
B=352 T=12 H=132 mm



5

ART. NR. F 22 SB D13238 00 00

Längseinteiler aus Aluminium
für Rahmen für BOX238
B=135 H=131 mm



6

ART. NR. F 22 SB D21238 00 00

Längseinteiler aus Aluminium
für Rahmen für BOX238
B=213 H=131 mm



7

ART. NR. F 22 SB D05238 00 00

Längseinteiler aus Aluminium
für Rahmen für BOX238
B=57 H=131 mm



STORE BOX374

ART. NR. F 22 SB BOX374 00 01

Kunststoffkoffer, leer B=442 T=357 H=389 mm

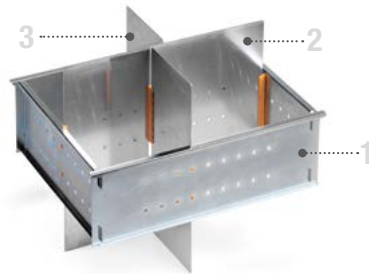

ART. NR. F 22 SB FRA374 01 99

B=402 T=312 H=330 mm

Einteilungsset mit:

1 Rahmen FRA238

1 Einteiler D36374

2 Einteiler D14374



1

ART. NR. F 22 SB FRA238 00 99

Verzinkter Stahlrahmen für Koffer
BOX238 - BOX374
B=402 T=312 H=132 mm



2

**ART. NR. F 22 SB D36374
00 00**

Quereinteiler aus Aluminium für
Rahmen für BOX374
B=352 T=12 H=330 mm



3

**ART. NR. F 22 SB D14374
00 00**

Längseinteiler aus Aluminium
für Rahmen für BOX374
B=135 H=329 mm

ART. NR. F 22 SB MAT002 00 07

Rutschfester Gummiteppich für
BOX374
B=362 T=290 H=1,5 mm

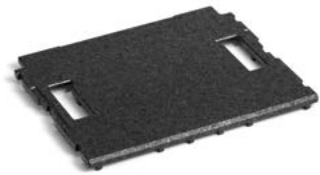
ART. NR. F 22 SB SKY001 00 07

Deckel Sky aus Polypropylen-Schaumstoff
B=400 T=320 H=20 mm

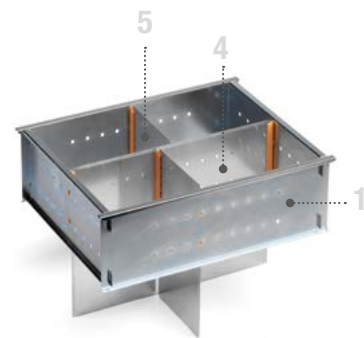
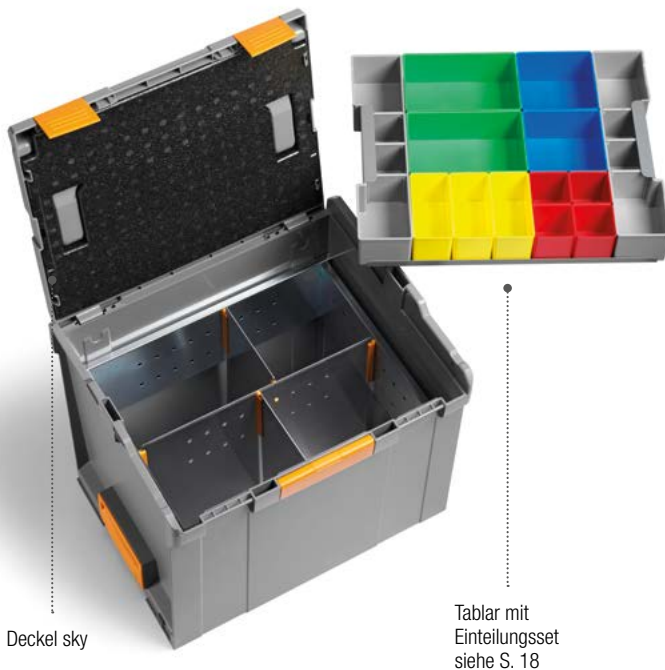
ART. NR. F 22 SB FRA374 02 99

B=402 T=312 H=260 mm
Einteilungsset mit:
1 Rahmen FRA238
1 Einteiler D35374
2 Einteiler D13374

ART. NR. F 22 SB FRA238 00 99

Verzinkter Stahlrahmen für Koffer
BOX238 - BOX374
B=402 T=312 H=132 mm



4

ART. NR. F 22 SB D35374 00 00

Quereinteiler aus Aluminium für
Rahmen für BOX374
B=352 T=12 H=260 mm



5

ART. NR. F 22 SB D13374 00 00

Längseinteiler aus Aluminium
für Rahmen für BOX374
B=135 H=259 mm

STORE BOXTRAY



ART. NR. F 22 SB 00TRAY 00 01

Stahltablar, leer für Store Box 136 - 238 - 374
B=380 T=313 H=65 mm



ART. NR. F 22 SB 00TRAY 01 01

Stahltablar mit 23 Fächern:
2 Insert Boxen "grey" mit Einteilern
6 Insert Boxen "red"
6 Insert Boxen "yellow"
3 Insert Boxen "blue"



ART. NR. F 22 SB 00TRAY 02 01

Stahltablar mit 19 Fächern:
2 Insert Boxen "grey" mit Einteilern
4 Insert Boxen "red"
3 Insert Boxen "yellow"
2 Insert Boxen "blue"
2 Insert Boxen "green"



ART. NR. F 22 SB 00TRAY 03 01

Stahltablar mit 18 Fächern:
2 Insert Boxen "grey" mit Einteilern
4 Insert Boxen "red"
3 Insert Boxen "yellow"
2 Insert Boxen "blue"
1 Insert Box "forest"



ART. NR. F 22 SB 00TRAY 04 01

Stahltablar mit 38 Fächern:
2 Insert Boxen "grey" mit Einteilern
30 Insert Boxen "red"



ART. NR. F 22 SB 00TRAY 05 01

Stahltablar mit 23 Fächern:
2 Insert Boxen "grey" mit Einteilern
15 Insert Boxen "yellow"



ART. NR. F 22 SB 00TRAY 06 01

Stahltablar mit 13 Fächern:
2 Insert Boxen "grey" mit Einteilern
5 Insert Boxen "green"

ART. NR. F 22 SB 00TRAY 07 01

Stahltablar mit 14 Fächern:
 2 Insert Boxen "grey" mit Einteilern
 2 Insert Boxen "red"
 2 Insert Boxen "yellow"
 2 Insert Boxen "forest"

ART. NR. F 22 SB 00TRAY 08 01

Stahltablar mit 17 Fächern:
 2 Insert Boxen "grey" mit Einteilern
 3 Insert Boxen "yellow"
 6 Insert Boxen "blue"

ART. NR. F 22 SB 00TRAY 09 01

Stahltablar mit 14 Fächern:
 2 Insert Boxen "grey" mit Einteilern
 3 Insert Boxen "blue"
 3 Insert Boxen "green"

ART. NR. F 22 SB 00TRAY 10 01

Stahltablar mit:
 2 Insert Boxen "grey" mit Einteilern
 2 store box mini63

ART. NR. F 22 SB 00TRAY 11 01

Stahltablar mit:
 1 Kleinteile-Organizer "dark" mit 5 Fächern

ART. NR. F 22 SB 00TRAY 12 01

Stahltablar mit:
 1 Kleinteile-Organizer "dark" mit 12 Fächern



STORE BOXDIVIDER

ART. NR. F 22 SB 000RED 63 03

Insert Box "red" B=52 T=52 H=63

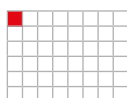

BOX067
BOX080

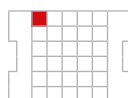

BOX102
BOXTRAY

ART. NR. F 22 SB YELLOW 63 05

Insert Box "yellow" B=52 T=104 H=63

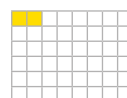

BOX067
BOX080

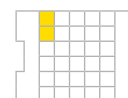

BOX102
BOXTRAY

ART. NR. F 22 SB 00BLUE 63 16

Insert Box "blue" B=104 T=104 H=63

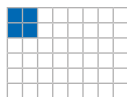

BOX067
BOX080

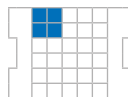

BOX102
BOXTRAY

ART. NR. F 22 SB 00GREEN 63 14

Insert Box "green" B=104 T=156 H=63

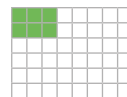

BOX067
BOX080

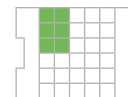

BOX102
BOXTRAY

ART. NR. F 22 SB FOREST 63 09

Insert Box "forest" B=104 T=312 H=63

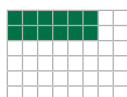

BOX067
BOX080

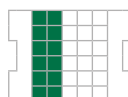

BOX102
BOXTRAY

ART. NR. F 22 SB MINI63 63 08

Store Box Mini63 B=260 T=155 H=63

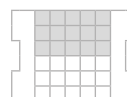

BOX102
BOXTRAY



ART. NR. F 22 SB 00GREY 63 01

Insert Box "grey" B=71 T=312 H=63

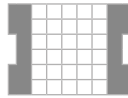

BOX102
BOXTRAY

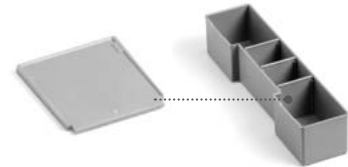

ART. NR. F 22 SB DVGREY 58 01

Einteilung für Insert Box "grey" B=52 T=4 H=58



ART. NR. F 22 SB DARK05 62 07

Kleinteile-Organizer "dark" mit 5 Fächern
B=405 T=315 H=62



BOX102
BOXTRAY



ART. NR. F 22 SB DARK12 62 07

Kleinteile-Organizer "dark" mit 12 Fächern
B=405 T=315 H=62



BOX102
BOXTRAY



STORE ROLL

ART. NR. F 22 SB 00ROLL 00 08

Wagen für Koffer BOX102 - 136 - 238 - 374
mit vier Laufrädern (davon 2 mit Bremse)
Tragfähigkeit 100 kg
B=650 T=510 H=150 mm





STORE CADDY

ART. NR. F 22 SB 0CADDY 00 00

Klappbare Transportkarre aus Aluminium
Tragfähigkeit 80 kg
Maße aufgeklappt B=490 T=490 H=1090 mm
Maße zusammengeklappt B=490 T=60 H=760 mm



LIEFERBEDINGUNGEN

- Bodenplatten und Seitenverkleidungen werden in mehreren Teilen geliefert.
- Dachträger und Leiterträger werden **lose** geliefert.
- Module werden **vormontiert** komplett mit Fahrzeugbefestigungsmaterial geliefert.
- Produkte sollen vorzugsweise von **Vertragshändlern** installiert werden.
- Produkte werden **verpackt** geliefert.
- **3 Jahre Garantie** auf unsere Komponenten.
- Die Tragkräfte beziehen sich auf **gleichmäßig verteilte Last**.

SUPPLY CONDITIONS

- Flooring and linings supplied in several pieces.
- Roof and ladder racks supplied **flat-packed**.
- Modules are supplied **preassembled** complete of fixing material to the vehicle.
- For products installation, please get in touch with our **approved installer's network**.
- Products provided **with packaging**.
- Our products are covered by a **3-years warranty**.
- Load capacities refer to **uniformly distributed loads**.

WWW.BAESTLEIN-FAHRZEUGEINRICHTUNGEN.DE

BÄSTLEIN GmbH
FAHRZEUGEINRICHTUNGEN

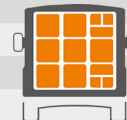

BÄSTLEIN-FAHRZEUGEINRICHTUNGEN GMBH
HANS- LINGL- STR. 12
86381 KRUMBACH/SCHWABEN

FON (+49) 0 82 82/89 06 610
FAX (+49) 0 82 82/89 06 612